



Your Sample Report

Your Tagline Goes Here

Your company address and contact information goes here, including website, email, and telephone.

THE HOME INSPECTION REPORT

Report #:

21070401 - Client Last Name

Property Address:

123 Main Street, Sample City, NY 12345

Date of Inspection:

07/04/2021 8:00 am - 11:00 am

Client's Representative:

**Nick Gromicko
Gromicko Real Estate**



This report is the exclusive property of the home inspection company and our client. Your Home Inspection Company is not responsible for misinterpretations by 3rd parties. The report is not transferable. The inspection was performed according to the InterNACHI® Home Inspection Standards of Practice, which is available prior to the inspection and at www.nachi.org/sop.

TABLE OF CONTENTS

THE HOME INSPECTION REPORT	1
GENERAL INFORMATION	2
WHAT REALLY MATTERS IN A HOME INSPECTION	3
INTRODUCTION, SCOPE, DEFINITIONS, & COMPLIANCE STATEMENT	4
Roof	5
Chimney	8
Exterior	11
Heating	16
Cooling	19
Plumbing	22
Electrical	27
Structure	30
Garage	34
Laundry	36
Attic	37
Bathrooms	39
Kitchen	42
Interior	44
Mold	46
Property	48
THE STANDARDS OF PRACTICE (abbreviated)	49
ILLUSTRATIONS	51
Report Conclusion	56

WHAT REALLY MATTERS IN A HOME INSPECTION

Congratulations on buying your new home.

The process can be stressful. A home inspection is supposed to give you peace of mind, but often has the opposite effect. You will be asked to absorb a lot of information in a short time. This often includes a written report, checklist, photographs, environmental reports, and what the inspector himself says during the inspection. All this combined with the seller's disclosure and what you notice yourself makes the experience even more overwhelming. What should you do?

Relax. Most of your inspection will be maintenance recommendations, life expectancies and minor imperfections. These are nice to know about. However, the issues that really matter will fall into four categories:

1. Major defects. An example of this would be a significant structural failure.
2. Things that may lead to major defects. A small water leak coming from a piece of roof flashing, for example.
3. Things that may hinder your ability to finance, legally occupy, or insure the home. Structural damaged caused by termite infestation, for example.
4. Safety hazards. Such as a lack of GFCI-protection.

Anything in these categories should be corrected. Often a serious problem can be corrected inexpensively to protect both life and property (especially in categories 2 and 4).

Most sellers are honest and are often surprised to learn of defects uncovered during an inspection. Realize that sellers are under no obligation to repair everything mentioned in the report. No home is perfect.

Keep things in perspective. Don't kill your deal over things that don't matter. It is inappropriate to demand that a seller address deferred maintenance, conditions already listed on the seller's disclosure, or nit-picky items.

INTRODUCTION, SCOPE, DEFINITIONS, & COMPLIANCE STATEMENT

INTRODUCTION: The following numbered and attached pages are your home inspection report. The report includes pictures, information, and recommendations. This inspection was performed in accordance with the current Standards of Practice and Code of Ethics of the American Society of Home Inspectors. The Standards contain certain and very important limitations, exceptions, and exclusions to the inspection. A copy is available prior to, during, and after the inspection, and it is part of the report. The cost estimates and video are not part of the bargained-for report.

SCOPE: This inspection complies and reflects with the provision of Act 114, Section 75, known as the PA Home Inspection Law. A home inspection is intended to assist in evaluating the overall condition of the dwelling. The inspection is based on observation of the visible, readily accessible and apparent condition of the structure and its components on this day. The results of this inspection are not intended to make any representation regarding the presence or absence of latent or concealed defects that are not reasonably ascertainable or readily accessible in a competently performed inspection.

No warranty, guarantee, or insurance by PEACH Inspections is expressed or implied. This report does not include inspection for wood destroying insects, mold, lead or asbestos. A representative sampling of the building components is viewed in areas that are accessible at the time of the inspection. No destructive testing or dismantling of components is performed. Not all defects will be identified during this inspection. Unexpected repairs should be anticipated.

The person conducting your inspection is not a licensed structural engineer or other professional whose license authorizes the rendering of an opinion as to the structural integrity of a building or its other component parts.

You are advised to seek two professional opinions and acquire estimates of repair as to any defects, comments, improvements or recommendations mentioned in this report. We recommend that the professional making any repairs inspect the property further, in order to discover and repair related problems that were not identified in the report. We recommend that all repairs, corrections, and cost estimates be completed and documented prior to closing or purchasing the property. Feel free to hire other professionals to inspect the property prior to closing, including HVAC professionals, electricians, engineers, or roofers.

TO BE CONCISE, the following phrases have been used in the report to identify systems or components that need your attention prior to closing or purchasing the property:

MONITORING RECOMMENDED: Denotes a system or component needing further evaluation and/or close observation in order to determine if correction is needed.

IMPROVEMENT AND REPAIR RECOMMENDED: Denotes a system or component that should receive normal maintenance, repair, or adjustment in order to function properly.

CORRECTION AND FURTHER EVALUATION RECOMMENDED: Denotes a system or component that is significantly deficient or at the end of its service life, and needs corrective action by a professional. We recommend the professional making any corrective action to inspect the property further (further evaluation), in order to discover and repair related problems that were not identified in the report. All corrections and evaluations must be made prior to closing or purchasing the property.

PENNSYLVANIA HOME INSPECTOR COMPLIANCE STATEMENT:

I represent that I am a full member in good standing of the National Association of Certified Home Inspectors (NACHI), www.nachi.org. Member #97010101. Certified Master Inspector ©

I will conduct a home inspection of the previously mentioned property in accordance with the ASHI Code of Ethics and Standards of Practice and the Home Inspection Agreement.

I am in compliance with the Pennsylvania Home Inspection Law.

I carry all the state-required insurance.

Ben Gromicko, PEACH Inspections

Roof

We are not professional roofers. Feel free to hire one prior to closing.

We do our best to inspect the roof system within the time allotted. We inspect the roof covering, drainage systems, the flashings, the skylights, chimneys, and roof penetrations. We are not required to inspect antennae, interiors of flues or chimneys which are not readily accessible, and other installed accessories. This is not an exhaustive inspection of every installation detail of the roof system according to the manufacturer's specifications or construction codes.

It is virtually impossible to detect a leak except as it is occurring or by specific water tests, which are beyond the scope of our inspection. We recommend that you ask the sellers to disclose information about the roof, and that you include comprehensive roof coverage in your home insurance policy.

Asphalt shingle For Your Information

The shingles are comprised of asphalt or fiberglass materials impregnated with mineral granules that are designed to deflect the deteriorating ultra-violet rays of the sun. The most common of these roofs are warranted by manufacturers to last from fifteen to twenty-five years. The actual service life of the roof will vary, depending on a number of interrelated factors including the quality of the material and the method of installation. Regular maintenance will certainly extend the life of any roof.

- See Attached Illustration 1



Please refer to the seller's disclosure in reference to the roof system, age, condition, prior problems, etc. Only the property owner would have intimate, accurate knowledge of the roof system. For example, I can only guess the age.



This inspection is not a guarantee that a roof leak in the future will not happen. Roofs leak. Even a roof that appears to be in good, functional condition may leak under certain circumstances. We will not take responsibility for a roof leak that happens in the future. This is not a warranty or guarantee of the roof system.



Method of Evaluation

I was unable to walk upon the roof surface because it was too slippery from dew. Inspection restriction. I moved my ladder around and inspected from the top of my ladder.

Estimated Age

Original to the house. Estimated to be the same age as the house.

The exact age is undetermined. I would guess between 10 and 15 years. Ask seller about exact age and warranties.

Condition

The asphalt shingle roof covering appears to be in good, functional condition. No major material defects. No major cracked, damaged, or missing shingles. Good. But this is not a guarantee against leaks in the future.



Flashings

The flashing around the vent stacks coming through the roof appear to be in good condition. Good.



Ventilation

There are soffit vents and ridge vents installed to ventilate the attic space. Good.



Gutters & Downspouts

The gutters and downspouts appear to be in functional condition. Good.



Chimney

We are not certified chimney professionals. Only a level two inspection performed by a CSIA (Chimney Safety Institute of America) certified chimney sweep can determine the condition of the flue and whether the fireplace is safe to use.

We recommend a cleaning and level two inspection of the fireplaces and chimney flues before closing. Clean chimneys don't catch on fire. More information about fireplaces and chimneys can be obtained at www.csia.com.

Gas-Venting Chimney Pipe Gas-Venting Metal Chimney Pipe

There is a chimney that is a pre-fabricated Type B gas chimney pipe, designed to carry away the exhaust of the gas-fired appliance(s) connected to it.

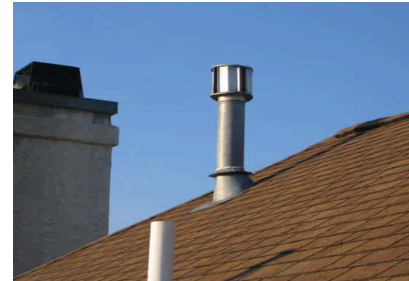

Chimney Flashings

A representative number of areas of chimney flashing were inspected. There is visible metal flashing installed around the chimney(s), where the chimneystack intersects the roof covering material.

Fireplace Chimney Prefabricated

There is a pre-fabricated chimney system.

- See Attached Illustration 2

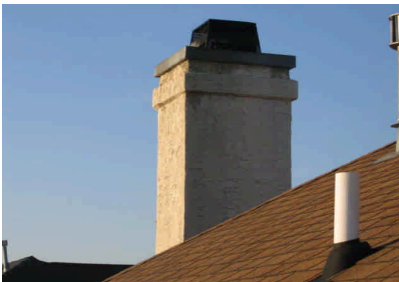

Observations

The chimney exterior sides appear to be in acceptable condition.



Unable to reach the top of the stack.

Chimney Flashings

MONITORING RECOMMENDED:

The chimney shingle flashing where the stack meets the roof is heavily sealed. Sealant is not permanent.



CORRECTION AND FURTHER EVALUATION RECOMMENDED:

There is no kickout flashing used at the roof-to-wall intersection. Correction by a professional roofer is recommended. Located at the sides of the chimney stack. This may be allowing water draining off the roof to miss the gutter and drain behind the siding exterior covering. If not corrected, this could lead to water penetration and damage inside the wall. Kickouts also prevent water from streaking down the siding exterior covering and causing water stains. We recommend a kickout flashing - an angled piece of metal secured to the roof - to be installed near the bottom of the roof, to direct water into the gutter and away from this siding area.



Major water damage visible from basement under the fireplace. Apparently caused by the missing flashing. Further evaluation of the structural integrity of the stack is recommended.



Fireplace Interior

The fireplace appears to be in functional condition. Major material defects are not apparent to me. But I'm not a certified chimney sweep. Consider having the chimney inspected by a professional.

A hairline crack is not a problem in a refractory firebox liner. They are made from cement and will eventually crack when exposed to heat. They usually have some type of reinforcement on the inside. It is designed to hold it together so that when it does get a hairline crack, it doesn't expand into a big open gap. If you can slip a quarter into the crack, replace the liner.

The fireplace grate that is inside the firebox is an integral part of that system. If it comes with a grate, that grate is not an optional component that the homeowner can use if they want or not.



Damper

The damper opened and closed with normal hand operation.

Exterior

We are not exterior experts. Feel free to hire an exterior contractor prior to closing.

Water can be destructive and foster conditions that can be harmful to health. For this reason, the ideal property will have the ground around the foundation perimeter that slopes away from the residence about 6 inches for the first 10 feet from the foundation. And the interior floors will be several inches higher than the exterior grade. Also, the residence will have roof gutters and downspouts that discharge into drains or trays that carry or divert water away from the foundation. The sellers or occupants will have a more intimate knowledge of the site than we will have during our limited visit. Recommend asking the seller about water problems including but not limited to water puddles in the yard, gutter or downspout problems, water penetration into the lowest level of the structure, and drainage systems. Recommend closely monitoring and inspecting the exterior during a heavy rainstorm to observe the way the surface water is managed. Standing puddles near the house foundation are to be avoided.

Surface Water Management Grading

The general grading around the house foundation perimeter appears functional. Good. Ideally the grading should slope about 6 inches over the first 10 feet away from the house foundation. Monitoring during a rainstorm is recommended.

- See Attached Illustration 3



Sump Pump Pipe

There is a drainage system which includes a sump pump. Its discharge pipe is visible.



Window Well

IMPROVEMENT AND REPAIR RECOMMENDED:

There's no window well cover. Consider installing one.



House Wall Coverings

Vinyl

We moved around the house exterior several times, inspecting the vinyl siding on the exterior of the house. Checked for loose panels, missing panels, warped panels, cracked or damaged panels. This inspection does not include determining whether the siding has been installed to code, rule, or manufacturer's recommendations.

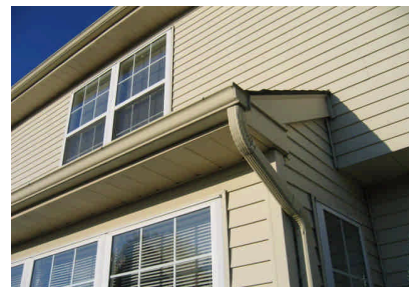

The vinyl siding appears functional. No major damage or deterioration was apparent. Recommend monitoring during a rain storm to see how the siding repels water. Be sure that the places where siding meets a different material is sealed or water-tight.

Brick

I moved around the structure exterior several times, inspecting the brick exterior of the house. Checked for loose bricks or mortar joints, missing pieces, damaged sections, deterioration, or failure. This inspection does not include determining whether the siding has been installed to code, rule, or manufacturer's recommendations.



The brick exterior covering appears functional. No major damage or deterioration apparent.

Exterior Components **Driveway or Parking**

The driveway appears functional.



Walks

The walkways that lead to the entry doors appear functional. Good.



Patio & Porch

The porch/patio appears functional. Good.

Steps & Handrails

The steps at the entry doors appear functional. Good.

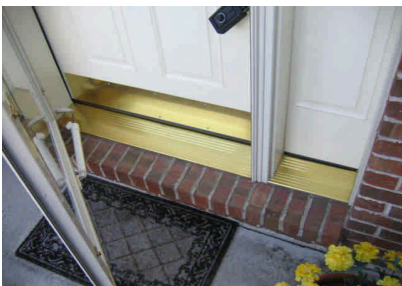

Exterior Water Faucets

The water faucet is frost-free. The faucet is designed so that it should not freeze and burst in the cold winter time. Good.

- See Attached Illustration 4



There is no running water at the faucet. Could be simply turned off. Recommend asking the seller. Located at the two faucets.

Receptacles & GFCIs

The exterior receptacles that were tested are functional and include ground-fault protection. Good.



Public Gas Meter

The main gas shut-off valve is located near the gas meter at the side of the house.

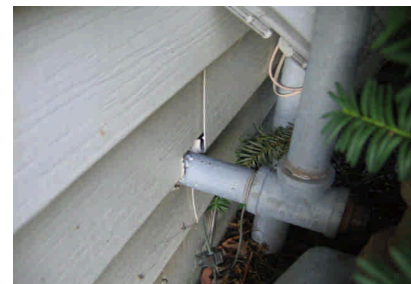

The gas meter has some surface rust on it.

Sealant needed around the gas line where it enters the house - minor.

Dryer Vent Hood

The dryer exhaust hood appears functional. No damage to hood or damper. No major lint build-up. We recommend inspecting and cleaning the dryer's exhaust pipe every year.



Lights

We do not inspect all of the spot lights and decorative garden lights. Some may be on timers. Or switches. Recommend asking the seller to demonstrate how well they work. Any low-voltage or garden lights installed would not be permanent and may not stay with the house.

Landscaping and Trees

Trees and Landscaping Observations

IMPROVEMENT AND REPAIR RECOMMENDED:

There's dense vegetation around the house perimeter. In contact with the house exterior walls and components. Trimming and maintenance is recommended.

Heating

We are not HVAC professionals. Feel free to hire one prior to closing.

This inspection of the heating system is a visual inspection using only the normal operating controls for the system. The inspection of the heating is general and not technically exhaustive. A detailed evaluation of the interior components of the heating system is beyond the scope of a home inspection. We do not inspect the humidifier or dehumidifier, the electronic air filter, and determine heating supply adequacy or distribution balance. We do not operate the heating system when the air temperature is too hot, to prevent damaging the unit.

It is essential that any recommendation that we make for service, correction, or repair be scheduled prior to closing or purchasing the property, because the hired-professional could reveal defects or recommend further repairs that could affect your evaluation of the property.

Note: Health is a deeply personal responsibility. You should have the air quality tested and the ductwork or baseboards cleaned as a prudent investment in environmental hygiene, especially if any family member suffers from allergies or asthma.

Gas-Fired Forced Air For Your Information

The heating system was inspected by using normal operating controls. We inspected for material defects. We are not HVAC professionals. Feel free to ask the seller to have the heating system inspected and certified by a HVAC professional prior to closing. Annual inspection and service is needed.

- See Attached Illustration 5

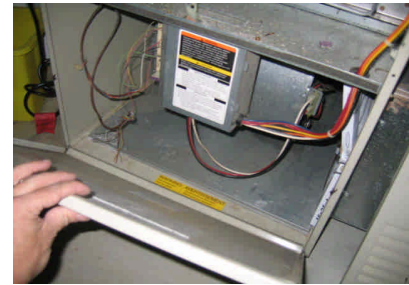
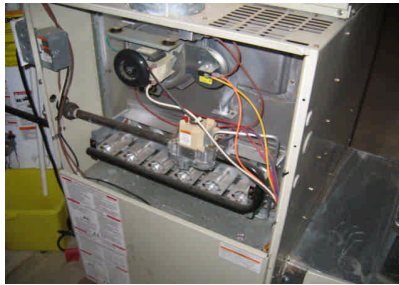

This inspection is not a guarantee or warranty of the system. Things break. We do not accept responsibility for any problems that may happen in the future. Please consult the seller's disclosure. Only the present owner/occupant of the property will have intimate, accurate knowledge of the system, including past performance and age. For example, I can only guess at the exact age.

Thermostat

The thermostat is functional.



There is a thermostat located on first floor.

The thermostat appears to be electronic and programmable. Nice. Ask seller for booklet on the thermostat.

Electric shut-off switch

There is an electrical shut-off switch located on the side of the heating system.

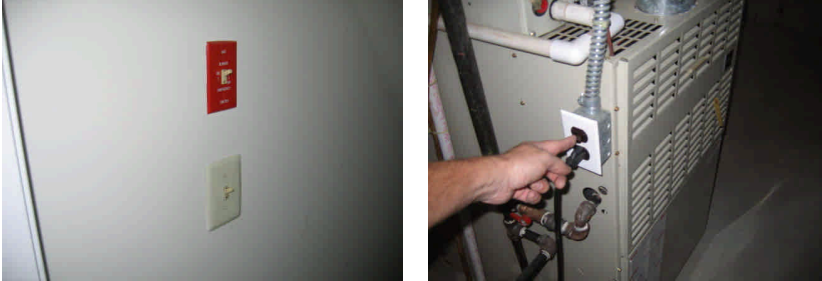

There is an emergency shut-off switch located at the basement stairs.

The electrical shut-off switch functioned. Good. I would use this switch when inspecting the air filter.

Gas shut-off valve

There is a gas shut-off valve near the heating system. Good.



Gas Burners

The gas burners of the heating system appear relatively clean. Good.



Air filter

The air filter is disposable and clean. Good. Check the filter every 30 days. Replace when necessary.

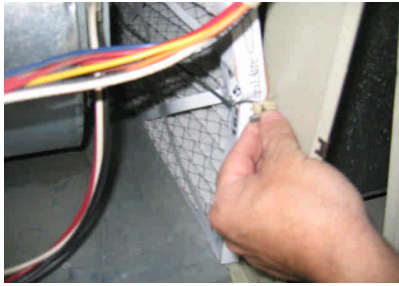

Service record

The last time the heating system was service has been recorded. Dated in 1994. The heating system should be serviced every year.

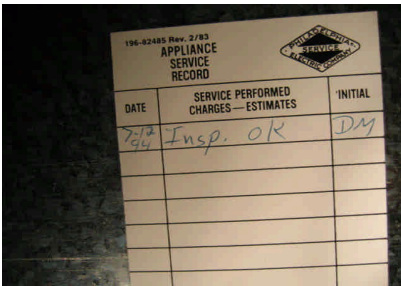

The heating system should be serviced every year by a HVAC professional technician. Make sure they record the service on a tag near the heating system, including date, name of technician, and what was done.

CORRECTION AND FURTHER EVALUATION RECOMMENDED:

Recommend having the heating system inspected, cleaned, and serviced by an HVAC professional prior to closing.

Inspection Restrictions

Since the property is occupied, I will not be able to confirm that every room has a heating and cooling source. Supply and return registers, baseboards and radiators, can be blocked or covered by personal items and furniture.

Estimated Age

The estimated age of the heating system is 10 to 15 years old, with 5 years of service life expected.

The average life expectancy is estimated from 15 to 25 years. Any system that is 15 years or older should be closely maintained, and budgeting for a replacement is recommended.

Cooling

We are not HVAC professionals. Feel free to hire one prior to closing.

We are not required to inspect the parts which are not readily accessible, like the coil, compressor, or valves. We do not inspect the humidifier or dehumidifier, the electronic air filter, and determine cooling supply adequacy or distribution balance. We do not operate the cooling system when the outside temperature is too cool, to prevent damaging the unit.

It is essential that any recommendation that we make for service, correction, or repair be scheduled prior to closing or purchasing the property, because the hired-professional could reveal additional defects or recommend further repairs that could affect your evaluation of the property.

Note: Health is a deeply personal responsibility. You should have the air quality tested and the ductwork or baseboards cleaned as a prudent investment in environmental hygiene, especially if any family member suffers from allergies or asthma.

Exterior Condenser Unit(s) For Your Information

This inspection is not a guarantee or warranty of the system. Things break. We do not accept responsibility for any problems that may happen in the future. Please consult the seller's disclosure. Only the present owner/occupant of the property will have intimate, accurate knowledge of the system, including past performance and age. For example, I can only guess at the exact age.

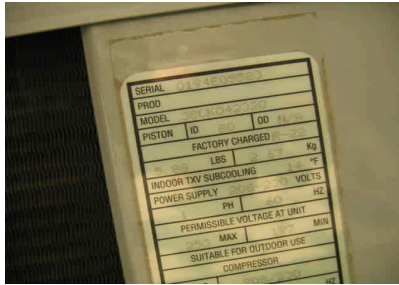

The air conditioner system was inspected. We only use only normal operating controls, such as the thermostat and electric switches. We are not HVAC professionals. Feel free to hire one prior to closing.

Level

MONITORING RECOMMENDED:

The exterior condenser unit appears level.

You need to monitor the way the unit rests on its base support. Sometimes a unit that rests upon the ground can all by itself start to settle off-level. A unit should be no more than 2 inches off level, measuring from one side to the opposite of the unit.

Electrical Disconnect

There is an electrical disconnect near the exterior condenser unit.



Estimated Age

The estimated age of the exterior condenser unit is 10 to 15 years old, with 5 years of service life expected.

The average life expectancy is estimated from 15 to 25 years. Any system that is 15 years or older should be closely maintained. And budgeting for a replacement is recommended.

Interior Evaporator Unit(s) For Your Information

We use normal operating controls to inspect the interior evaporator coil unit. We use the thermostat. We inspect the condensate drainage. Check the insulation around the refrigerant line. Check for major rust and corrosion on the unit. Check for condensate water leakage and damage. Inspect the air filter.

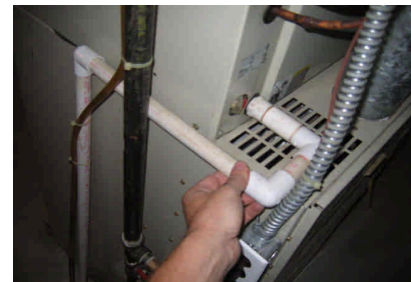
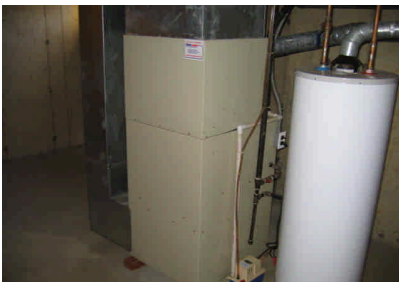

The thermostat for the cooling is the same as the heater's thermostat.
The electric shut-off switch is the same as the heater's.
The air filter is the same as the heater's filter.

Location of Interior Evaporator

There is an interior evaporator unit located at the heating system.

Condensate Drainage

The condensation drains from the unit to a condensate pump. Appears to be functional.

Inspection Address: Honeysuckle Court, Yardley, PA 19067
Inspection Date/Time: 10/1/2007 8:00 am to 11:00 am



Service Record

There is no visible recent-service tag on the air conditioning system. Possibly indicating delayed maintenance. Recommend having the system cleaned, inspected, and serviced by an HVAC professional.

Plumbing

We are not professional plumbers. Feel free to hire one prior to closing.

All bathroom fixtures, including toilets, tubs, showers, and sinks are inspected. Approximately 15 minutes of water is run at each fixture. Readily visible water-supply and drain pipes are inspected. Plumbing access panels that we can find are opened, if readily accessible and available to open. We do not perform water leak tests on drain lines or shower pans. We simply look for active leaks, which is quite limited by our short time in the property.

Drain Waste Vent Pipes Type of Material

Visible portions of the drainpipes are of PVC, poly vinyl chloride. Very commonly used material.



Not all of the drain pipes were readily visible. Much of the pipes are inside the walls.

Condition of Drain Waste & Vent Pipes

No major problems with the visible waste and drainage pipes are apparent. Good.

Clean-out fitting is visible.

Public Water Supply Main Water Shut-off Valve

The main water shut-off valve is located in the basement.



CORRECTION AND FURTHER EVALUATION RECOMMENDED:

There is a noticeable low flow of hot water at the bathroom fixtures. Only one fixture can run hot water at a time. Further evaluation by a plumber is recommended.

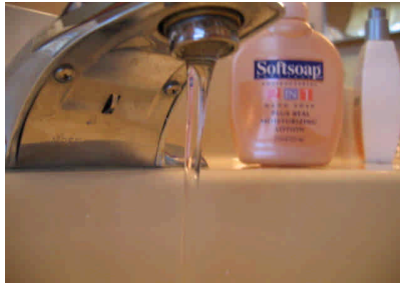

Water Meter

The water meter is located near the main water shut-off valve.

There are no active water leaks at meter. Good.

Check Valve & Expansion Tank

CORRECTION AND FURTHER EVALUATION RECOMMENDED:

There is a pressure regulator installed on the main water supply line coming into the house. This regulator has a valve that prevents water from pushing back out to the street, and makes the plumbing system a closed water system. When the water heater makes hot water, the water in the system expands. The expansion of the warm water increases the pressure on the homes water pipes. An expansion tank installed on the water line would absorb the extra pressure. There isn't one installed through. The relief valve on the water tank may start to drip, because of the lack of an expansion tank. The action of the expansion tank also reduces knocking of the pipes, and wear and tear on the faucets and shut-off valves in the home. We recommend installing an expansion tank.

The relief valve on the hot water tank is actively leaking water into a bucket.



Jumper Cable at Meter

There is a jumper cable installed over the water meter - Good.

- See Attached Illustration 6



Water Supply Pipes Copper Water Pipes

The visible water supply pipes appear to be copper. No active water leaks were apparent. Good.

Not all of the water supply pipes are readily visible. Much of the pipes are inside the walls and ceilings.

Gas Water Heater For Your Information

There are a wide variety of residential water heaters. They can be expected to last at least as long as their warranty, or from five to eight years, but they will generally last longer. However, few of them last longer than fifteen or twenty years and many eventually leak.

- See *Attached Illustration 7*

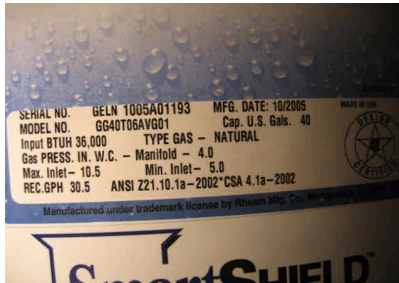

Size

The water heater is 40 gallons in size.

Age

Gas water heater tanks have service lives between 12 and 18 years typically. Any tank that is older than 12 years should be monitored closely for performance and failure. When a tank reaches 12 years in age, budgeting for a new tank is recommended.

The water heater tank is newer.

Water Shut-Off Valve & Connectors

The water shut-off valve to the water heater tank is installed. Not leaking. This valve turns off the cold water supply to the tank. Good.



Gas Shut-Off Valve

The gas shut-off valve at the water heater is installed within reach of the tank. This valve turns off the gas supply to the tank. Good.

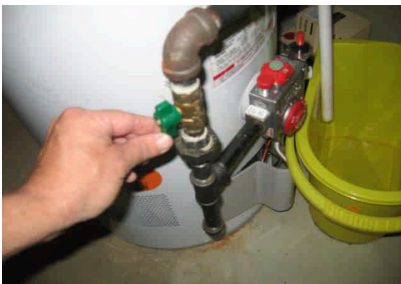

Relief Valve & Discharge Pipe

The pressure temperature valve is a safety device that opens up and releases pressure (and hot scalding water) from the tank. This opening of the valve would happen if there's an excessive build-up of pressure or extreme temperatures in the water tank. The end of the pipe should be conspicuous, so that you can easily notice if it is leaking or discharging water. If the valve is discharging, something is wrong, turn off the water valve, turn off the gas, and call a plumber. All hot-water-distribution pipe and tubing shall have a minimum pressure rating of 100 psi at 180°F.

CORRECTION AND FURTHER EVALUATION RECOMMENDED:

The pressure relief valve on the water heater is dripping water - leaking. Indication of a failure in the relief valve itself, or a pressure/temperature problem with the water heater tank.



Water Leak Catch Pan

IMPROVEMENT AND REPAIR RECOMMENDED:

The water heater is not equipped with a water leak catch pan. Consider installing one. A pan under the tank is designed to prevent or minimize water damage from a leak.

Electrical

We are not electricians. Feel free to hire an electrician prior to closing.

If we feel that it is safe enough to open the electrical panel, we will check the interior components of service panels and sub panels, the conductors, and the over-current protection devices. Inside the house, we will check a representative number of installed lighting fixtures, switches, and receptacles. This is not an exhaustive inspection of every component and installation detail. There will be receptacles and switches and lights that we will not have time to inspect. Ask property owner about all of the wall switches.

Therefore, it is essential that any recommendations that we may make for correction should be completed before the close of escrow, because an electrician could reveal other problems or recommend repairs.

Meter

Number of Meters & Location

There is one electric meter.



The meter is located on the left-side of the house.

Meter Condition

The meter box exterior appears functional. No major rust or damage. Not loose. Good.

Grounding Outside

There is a grounding wire visible outside. Good.

Main Electric Service Line

The main electric service line is underground.

The line appears to be in good shape. No major damage.

Main Panel

Location of Panel

The main panel is located in the basement.

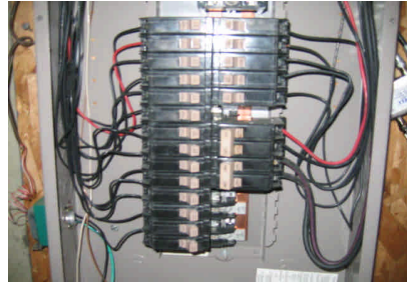

Main Disconnect & Panel Size in Amps

The main disconnect is installed.

The main electrical panel appears to be 200-amps.

Breaker Labeling

All of the breakers seem to be labeled. Good.

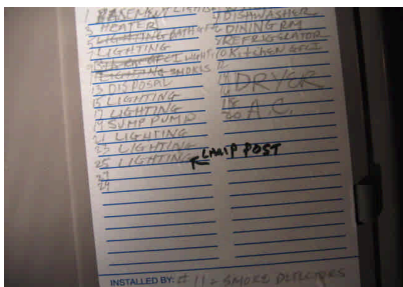

Wiring Type

Modern Romex wiring is visible. Good.

Circuit Breakers

There is apparently open room for additional breakers and circuits.

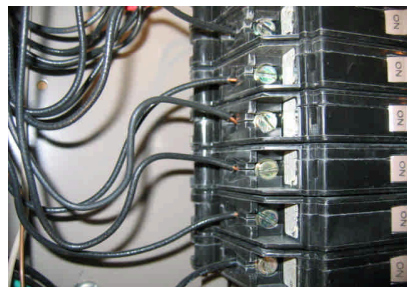
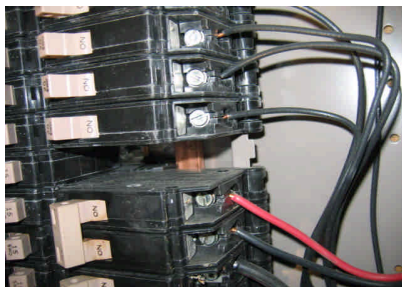
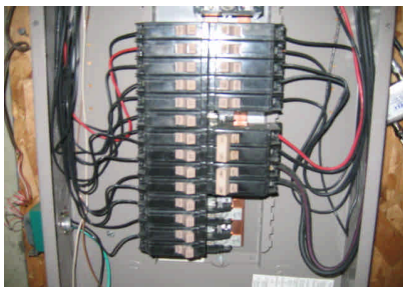

The system does not include arc-fault circuit interrupters, which effective January 1st, 2002, are mandated by the national electrical code to protect 15 and 20 amp branch circuits serving bedrooms in new construction. This is not a new home, so simply consider the benefit of installing them.

Inspection Address: Honeysuckle Court, Yardley, PA 19067
Inspection Date/Time: 10/1/2007 8:00 am to 11:00 am

AFCI breakers are required to be installed on all the bedroom circuits. These safety devices are intended to detect the kinds of electrical arcs that can cause fires. An AFCI breaker is designed to trip when it detects a dangerous arc, either in the house wiring or in a defective extension cord or appliance.

Inspection Sticker

There is an inspection sticker. Dated 7/94. Ask seller if there's been any electrical work performed, and permits for that work issued, since the panel was installed or inspected last.

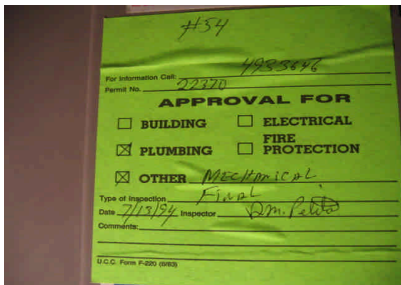

Structure

We are not structural engineers. Feel free to hire one prior to closing to consult with and address concerns that you have with the property, even if I do not identify any structural material defects.

We inspect the structural components including foundation and framing by probing a representative number of structural components where deterioration is suspected or where clear indications of possible deterioration exist. Probing is not required when probing would damage any finished surface or where no deterioration is visible.

Basement For Your Information

This residence has a basement. We try to enter and inspect all accessible areas, looking for any evidence of structural material defects. We look for cracks, but those that are less than ¼" and which do not exhibit any vertical or horizontal displacement are generally not regarded as being material structural defects. We look for signs of water penetration too, but please consult the seller's disclosure.



Basement Restrictions

We do all we can to see everything in the unfinished basement. There are restrictions to the inspection though. Including but not limited to the electrical wires, pipes, storage, ductwork, insulation, floor coverings, etc.



There is insulation at the band or rim joint areas, which is above the foundation wall, at the outer perimeter of the floor system. This insulation restricts the visual inspection of those areas considerably.

Poured Concrete Foundation

The poured concrete foundation of the structure appears to be functional. Readily accessible areas were inspected. There are no indications of major material defects apparent.

CORRECTION AND FURTHER EVALUATION RECOMMENDED:

There are indications of previous ground water penetration through a foundation crack. Water marks. It has leaked in the past and may likely leak again in the future. Ask seller when the crack leaked in the past. Located at the left-side wall, near electrical panel.



There are dry water marks around the sewer line. Located on the front wall.



Foundation cracks can be repaired using an epoxy ejection method. Epoxy ejection repairs are considered affordable and effective. Epoxy ejections make a bond between the cracked sections of the foundation that is actually stronger than the concrete itself. Further evaluation and correction to the foundation crack(s) by a professional (one familiar with epoxy injection repairs) is recommended.

Floor Type and Condition

MONITORING RECOMMENDED:

There are water stains in areas on the floor under the rear exterior door. Possible water problems in the past. Ask seller.



The floor joists are made of dimensional wood lumber - 2x10s.



There have been structural repairs to floor under front entry door. Ask seller about prior repairs and possible water penetration problems.



CORRECTION AND FURTHER EVALUATION RECOMMENDED:

There is major water damage at floor components. Above the foundation wall. Located under the fireplace.



Water

There are no signs of active, wet ground water penetration in the basement. The lowest living level appears dry today. Monitoring during a heavy rain storm or snow melt is recommended. Consult with the seller's disclosure.

In the short time of this inspection, it is not possible to determine prior or future ground water penetration problems. Conditions that affect the structure's dryness (weather, wind, and temperature) will vary greatly during the course of a year. We recommend referring to the seller's disclosure document to determine if there ever has been any water leakage, accumulation, or dampness.

Sump Pump

There is a sump pump being used. Recommend asking the seller why a sump pump has been installed. Has there been water penetration problems that required the pump to be installed?

- See Attached Illustration 8

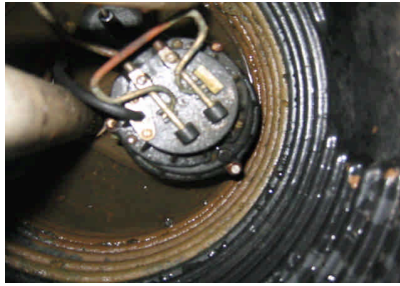

There is water in the sump pit.

The pump turned on.

Discharged water.



A check-valve is installed on the sump pump's discharge pipe. Good.

Garage

We do not evaluate or measure the fire-ratings of the drywall/plaster in the garage or the rating of the door between the garage and the house. Different townships require different ratings. Ideally, there should be a 5/8-inch Type X drywall or equivalent on the walls and ceiling that separate the garage from habitable rooms. And a 20-minute fire-rated door separating the house and garage. We check for breaches of the firewall. We do not pressure test the garage door openers.

Attached Garage Garage Door Opener

Each garage door opener is functional. With functional infra-red sensors.

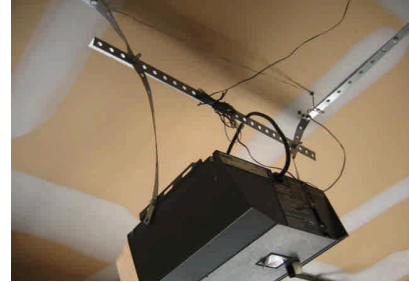

IMPROVEMENT AND REPAIR RECOMMENDED:

The infra red auto-reversing sensor mechanisms are functional but located higher than the recommended six inches above grade.

Walls & Ceiling

The finished walls and ceiling appear in good condition.



Slab Floor

The concrete slab floor is in acceptable condition. Small cracks are common and result as a consequence of the curing process and common settling. Typically they are not structurally threatening.

Receptacles

CORRECTION AND FURTHER EVALUATION RECOMMENDED:

The receptacle in the garage (left-side wall) should be upgraded to have GFCI or ground-fault protection, which is required by current standards and is an important safety feature.

Inspection Address: Honeysuckle Court, Yardley, PA 19067
Inspection Date/Time: 10/1/2007 8:00 am to 11:00 am



Inspection Restrictions

The inspection is restricted in some ways by the stored items, boxes and cluttered condition. Unable to see everything. Recommend re-inspecting after everything has been removed and cleaned up.

Laundry

We do not test clothes dryers, nor washing machines and their water connections and drainpipes. We can operate them, but only as courtesy. If a water catch pan is installed, it is not possible for us to check its performance. We recommend turning off the water supplied to the washer after every load. We recommend having a professional inspect and clean the dryer exhaust pipe twice every year.

Laundry Room

Dryer Vent

MONITORING RECOMMENDED:

Faulty dryer vents have been responsible for thousands of fires, hundreds of injuries, and even deaths. The best vents are a smooth-walled metal type that travels a short distance; all other types should be regarded as suspect, and should be inspected bi-annually to ensure that they do not contain trapped lint or moisture.



The laundry dryer vent pipe seems functional.

Water Supply Hoses

IMPROVEMENT AND REPAIR RECOMMENDED:

Rubber hoses should be replaced with more reliable ones - pressure-tested hoses. Such as stainless-steel, braided mesh hoses.



Gas Valve

The gas shut-off valve is installed.

Water Leak Catch Pan

IMPROVEMENT AND REPAIR RECOMMENDED:

There's no water leak catch pan installed under the clothes washer. To catch leaks before causing water damage. Correction by a plumber is recommended.

Attic

Primary Attic Space

Method of Evaluation

We inspected the attic by entering it. But there is no flooring, and the insulation is covering the joists. I am unable to safely move all around the attic space completely. Inspection restrictions.



Framing

The roof framing consists of an engineered truss system, comprised of components called chords, webs, and struts that are connected by wood or metal gussets nailed or glued in place. Each component of the truss is designed for a specific purpose, and cannot be removed or modified without compromising the integrity of the entire truss. The lowest component, which is called the chord and to which the ceiling is attached, can move by thermal expansion and contraction, and may cause common drywall pops and drywall cracks.

- See Attached Illustration 9



Water Penetration

No signs of active water penetration visible today.

Insulation

Type of Insulation

Cellulose insulation is installed. Cellulose building thermal insulation is a recycled product made from recovered newsprint, the largest single component of the residential waste stream in most communities.



Thickness

Appears well insulated.

Bathrooms

We are not plumbers. Feel free to hire a plumber prior to closing.

All bathroom fixtures, including toilets, tubs, showers, and sinks are inspected. Approximately 15 minutes of water is run at each fixture. Readily visible water-supply and drain pipes are inspected. Plumbing access panels are opened, if readily accessible and available to open. Normal foot pressure is applied around the base of each toilet, tub, and shower to check for deteriorated flooring. Normal hand pressure is applied carefully to the walls of each shower to check for deterioration. Re-grouting and sealant around the tub/shower, and fixtures should be considered routine maintenance. We do not perform water leak tests on drain lines or shower pans. We simply look for active leaks, which is quite limited by our short time in the property.

Master Bathroom **No Recommended Service**

We inspected the bathroom, and found no major defects. Toilet flushed a couple times. Running water at the sink. Sink drained. The tub/shower functional. No active leaks.



Master Bath Receptacles

The receptacles are testing functional and include ground-fault protection (GFCI). Good.

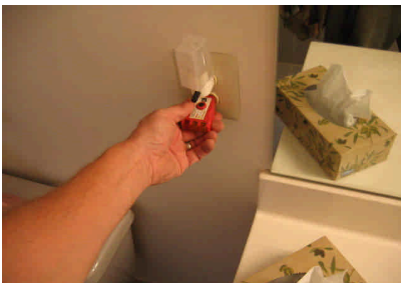

Access panel

IMPROVEMENT AND REPAIR RECOMMENDED:

The shower does not have a plumbing access panel installed. To gain access to the plumbing, one would have to be installed. Consider installing one.

2nd Floor Full Bathroom **No Recommended Service**

We inspected the bathroom, and found no major defects. Toilet flushed a couple times. Running water at the sink. Sink drained. The tub/shower functional. No active leaks.



2nd Floor Bath Receptacles

The receptacles are testing functional and include ground-fault protection (GFCI). Good.

Access panel

There is an access panel for the tub. It was opened. No water leaks. Good.



First Floor Half Bathroom **No Recommended Service**

We inspected the 1/2 bathroom, and found no major defects. Running water at the sink. Toilet flushed a couple times. Sink drained. No active leaks.



Half Bath Receptacles

The receptacles are testing functional and include ground-fault protection (GFCI). Good.

Kitchen

We check some of the appliances only as a courtesy to you. Appliances are not within the scope of a home inspection. We are not required to inspect the kitchen appliances. We do not evaluate them for their performance nor for the accuracy of their settings or cycles. Appliances break. We assume no responsibility for future problems with the appliances.

If they are older than ten years, they may well exhibit decreased efficiency. Also, many older ovens are not secured to the wall to prevent tipping. Be sure to check the appliance, especially if children are in the house. We recommend installing a minimum five pound ABC-type fire extinguisher mounted on the wall inside the kitchen area.

The Kitchen

Faucet

The sink faucet is functional. No active leaks seen.



Garbage Disposal

CORRECTION AND FURTHER EVALUATION RECOMMENDED:

The garbage disposal is excessively noisy and rumbless, which may be attributable to worn or damaged components.

Receptacles and GFCI

CORRECTION AND FURTHER EVALUATION RECOMMENDED:

Missing GFCI-protection at the kitchen counter receptacles. All of the countertop and island receptacles should be upgraded to have ground fault GFCI protection, which is mandated by current standards and is an important safety feature. Right of stove.



Dishwasher

Ran a short cycle with no leaks. (This is no guarantee against future problems.)



Gas Cooktop

The gas cook top elements turned on.



Gas Oven

The gas oven is functional. Turned on and warmed up. Good.

Exhaust Fan

The exhaust fan is a type that vents internally.

Interior

We check only a representative number of doors and windows. We are not required to inspect the paint, wallpaper, the carpeting, the window treatments and screens. We do not move furniture, lift carpets or rugs, empty closets or cabinets, and we do not comment on cosmetic deficiencies. We may not comment on the cracks that appear around windows and doors, or which follow the lines of framing members and the seams of drywall and plasterboard. These cracks are usually a consequence of movement, such as wood shrinkage and common settling, and will often reappear. We do not report on odors from pets and cigarette smoke.

Carbon Monoxide Detectors For Your Information

There is a fuel-fired heating system in the house. Carbon monoxide detector is recommended.

The hot water source is a fuel-fired system. Carbon monoxide detector is recommended.

There is a fuel burning fireplace in the house. Carbon monoxide detector recommended.

IMPROVEMENT AND REPAIR RECOMMENDED:

Recommend asking the seller if there are carbon monoxide detectors installed in the house that will be staying with the house. Recommend installing new detectors in the house, according to the manufacturer's recommendation.

Smoke Detectors Smoke Detectors

Ideally there should be smoke detectors installed on every floor, including the basement and the attic space, inside every bedroom, and in the hallway outside the bedrooms. The detectors should be hard-wired with battery back-up.

Most manufacturers recommend testing detectors every week. And replacing the detectors every 10 years.

The installed detectors were manually tested by pushing the test button. All tested functional.

Windows Observations

The ones that I inspected seemed functional.

Doors Observations

The condition of the doors that I inspected seemed functional.

Inspection Address: Honeysuckle Court, Yardley, PA 19067
Inspection Date/Time: 10/1/2007 8:00 am to 11:00 am

Receptacles
Observations

The ones that I tested seemed to be wired functional.

Mold

Visible Signs of Mold

Mold in the Basement

CORRECTION AND FURTHER EVALUATION RECOMMENDED:

Signs of mold growth is visible in the basement. The mold is in the insulation under the fireplace.

Mold is often associated with excess moisture and can be a problem in indoor environments at high levels. Some molds have the potential to cause health problems. Some molds can produce allergens (substances that can cause allergic reactions), irritants, and in some cases, potentially toxic substances (mycotoxins). Since there is mold growth in the home, the mold must be cleaned up and the water problem must be fixed. If the mold is cleaned up, but the water problem is not fixed, then, most likely, the mold problem will come back. According to the U.S. EPA in their booklet: A Brief Guide to Mold, Moisture, and Your Home, since the moldy area is less than about 10 square feet, in most cases, a home owner can handle the job of cleaning up the mold. If you do not choose to do the mold cleanup, then contacting an indoor air quality professional to assist in the determination of appropriate actions is necessary. The U.S. Environmental Protection Agency has set some mold cleanup guidelines. For more information, visit www.epa.gov/iaq/molds/moldguide.html.



10 Things to Know About Mold

Ten Things You Should Know About Mold:

1. Potential health effects and symptoms associated with mold exposures include allergic reactions, asthma, and other respiratory complaints.
2. There is no practical way to eliminate all mold and mold spores in the indoor environment; the way to control indoor mold growth is to control moisture.
3. If mold is a problem in your home or school, you must clean up the mold and eliminate sources of moisture.
4. Fix the source of the water problem or leak to prevent mold growth.
5. Reduce indoor humidity (to 30-60%) to decrease mold growth by:
 - a. venting bathrooms, dryers, and other moisture-generating sources to the outside;
 - b. using air conditioners and de-humidifiers;
 - c. increasing ventilation;
 - d. and using exhaust fans whenever cooking, dishwashing, and cleaning.
6. Clean and dry any damp or wet building materials and furnishings within 24-48 hours to prevent mold growth.
7. Clean mold off hard surfaces with water and detergent, and dry completely. Absorbent materials such as ceiling tiles, that are moldy, may need to be replaced.
8. Prevent condensation: Reduce the potential for condensation on cold surfaces (i.e., windows, piping, exterior walls, roof, or floors) by adding insulation.
9. In areas where there is a perpetual moisture problem, do not install carpeting (i.e., by drinking fountains, by classroom sinks, or on concrete floors with leaks or frequent condensation).
10. Molds can be found almost anywhere; they can grow on virtually any substance, providing moisture is present. There are molds that can grow on wood, paper, carpet, and foods.

Property

Observations at the Property Our Client

We prefer to have our clients present during the entire inspection. For a few reasons, including: (1) We can answer all of your questions and address your concerns as they come up. (2) We both can see the condition of the property at the time of the inspection. (3) I can elaborate on what may be complicated or technical. Inasmuch as you were not present during the entire inspection, we encourage you to read the whole report and not just the summary report, and to consult with us directly. Call us anytime. You can hire us again for a walk-through prior to closing. Also, please verify anything that we may have been said orally, but may not have documented in the report.



THE STANDARDS OF PRACTICE (abbreviated)

2. PURPOSE AND SCOPE 2.2 Inspectors shall: A. adhere to the Code of Ethics of the American Society of Home Inspectors. B. inspect readily accessible, visually observable, installed systems and components listed in these Standards of Practice. C. report: 1. those systems and components inspected that, in the professional judgment of the inspector, are not functioning properly, significantly deficient, unsafe, or are near the end of their service lives. 2. recommendations to correct, or monitor for future correction, the deficiencies reported in 2.2.C.1, or items needing further evaluation. (Per Exclusion 13.2.A.5 inspectors are NOT required to determine methods, materials, or costs of corrections.) 3. reasoning or explanation as to the nature of the deficiencies reported in 2.2.C.1, that are not self-evident. 4. systems and components designated for inspection in these Standards of Practice that were present at the time of the home inspection but were not inspected and the reason(s) they were not inspected. 2.3 These Standards of Practice are not intended to limit inspectors from: A. including other inspection services or systems and components in addition to those required in Section 2.2.B. B. designing or specifying repairs, provided the inspector is appropriately qualified and willing to do so. C. excluding systems and components from the inspection if requested by the client.

3. STRUCTURAL COMPONENTS 3.1 The inspector shall: A. inspect: 1. structural components including the foundation and framing. 2. by probing a representative number of structural components where deterioration is suspected or where clear indications of possible deterioration exist. Probing is NOT required when probing would damage any finished surface or where no deterioration is visible or presumed to exist. B. describe: 1. the methods used to inspect under-floor crawl spaces and attics. 2. the foundation. 3. the floor structure. 4. the wall structure. 5. the ceiling structure. 6. the roof structure. 3.2 The inspector is NOT required to: A. provide any engineering or architectural services or analysis. B. offer an opinion as to the adequacy of any structural system or component.

4. EXTERIOR 4.1 The inspector shall: A. inspect: 1. siding, flashing and trim. 2. all exterior doors. 3. attached or adjacent decks, balconies, stoops, steps, porches, and their associated railings. 4. eaves, soffits, and fascias where accessible from the ground level. 5. vegetation, grading, surface drainage, and retaining walls that are likely to adversely affect the building. 6. adjacent or entryway walkways, patios, and driveways. B. describe: 1. siding. 4.2 The inspector is NOT required to inspect: A. screening, shutters, awnings, and similar seasonal accessories. B. fences. C. geological and/or soil conditions. D. recreational facilities. E. outbuildings other than garages and carports. F. seawalls, break-walls, and docks. G. erosion control and earth stabilization measures.

5. ROOFING 5.1 The inspector shall: A. inspect: 1. roofing materials. 2. roof drainage systems. 3. flashing. 4. skylights, chimneys, and roof penetrations. B. describe: 1. roofing materials. 2. methods used to inspect the roofing. 5.2 The inspector is NOT required to inspect: A. antennae. B. interiors of flues or chimneys that are not readily accessible. C. other installed accessories. 6. PLUMBING 6.1 The inspector shall: A. inspect: 1. interior water supply and distribution systems including all fixtures and faucets. 2. drain, waste, and vent systems including all fixtures. 3. water heating equipment and hot water supply system. 4. vent systems, flues, and chimneys. 5. fuel storage and fuel distribution systems. 6. drainage sumps, sump pumps, and related piping. B. describe: 1. water supply, drain, waste, and vent piping materials. 2. water heating equipment including energy source(s). 3. location of main water and fuel shut-off valves. 6.2 The inspector is NOT required to: A. inspect: 1. clothes washing machine connections. 2. interiors of flues or chimneys that are not readily accessible. 3. wells, well pumps, or water storage related equipment. 4. water conditioning systems. 5. solar water heating systems. 6. fire and lawn sprinkler systems. 7. private waste disposal systems. B. determine: 1. whether water supply and waste disposal systems are public or private. 2. water supply quantity or quality. C. operate automatic safety controls or manual stop valves.

7. ELECTRICAL 7.1 The inspector shall: A. inspect: 1. service drop. 2. service entrance conductors, cables, and raceways. 3. service equipment and main disconnects. 4. service grounding. 5. interior components of service panels and sub panels. 6. conductors. 7. over current protection devices. 8. a representative number of installed lighting fixtures, switches, and receptacles. 9. ground fault circuit interrupters. B. describe: 1. amperage and voltage rating of the service. 2. location of main disconnect(s) and sub panels. 3. presence of solid conductor aluminum branch circuit wiring. 4. presence or absence of smoke detectors. 5. wiring methods. 7.2 The inspector is NOT required to: A. inspect: 1. remote control devices. 2. alarm systems and components. 3. low voltage wiring systems and components. 4. ancillary wiring systems and components. not a part of the primary electrical power distribution system. B. measure amperage, voltage, or impedance.

8. HEATING 8.1 The inspector shall: A. open readily openable access panels. B. inspect: 1. installed heating equipment. 2. vent systems, flues, and chimneys. C. describe: 1. energy source(s). 2. heating systems. 8.2 The inspector is NOT required to: A. inspect: 1. interiors of flues or chimneys that are not readily accessible. 2. heat

exchangers. 3. humidifiers or dehumidifiers. 4. electronic air filters. 5. solar space heating systems. B. determine heat supply adequacy or distribution balance.

9. AIR CONDITIONING 9.1 The inspector shall: A. open readily openable access panels. B. inspect: 1. central and through-wall equipment. 2. distribution systems. C. describe: 1. energy source(s). 2. cooling systems. 9.2 The inspector is NOT required to: A. inspect electronic air filters. B. determine cooling supply adequacy or distribution balance. C. inspect window air conditioning units.

10. INTERIORS 10.1 The inspector shall inspect: A. walls, ceilings, and floors. B. steps, stairways, and railings. C. countertops and a representative number of installed cabinets. D. a representative number of doors and windows. E. garage doors and garage door operators. 10.2 The inspector is NOT required to inspect: A. paint, wallpaper, and other finish treatments. B. carpeting. C. window treatments. D. central vacuum systems. E. household appliances. F. recreational facilities.

11. INSULATION & VENTILATION 11.1 The inspector shall: A. inspect: 1. insulation and vapor retarders in unfinished spaces. 2. ventilation of attics and foundation areas. 3. mechanical ventilation systems. B. describe: 1. insulation and vapor retarders in unfinished spaces. 2. absence of insulation in unfinished spaces at conditioned surfaces. 11.2 The inspector is NOT required to disturb insulation.

12. FIREPLACES AND SOLID FUEL BURNING APPLIANCES 12.1 The inspector shall: A. inspect: 1. system components. 2. chimney and vents. B. describe: 1. fireplaces and solid fuel burning appliances. 2. chimneys. 12.2 The inspector is NOT required to: A. inspect: 1. interiors of flues or chimneys. 2. fire screens and doors. 3. seals and gaskets. 4. automatic fuel feed devices. 5. mantles and fireplace surrounds. 6. combustion make-up air devices. 7. heat distribution assists (gravity fed and fan assisted). B. ignite or extinguish fires. C. determine draft characteristics. D. move fireplace inserts and stoves or firebox contents.

13. GENERAL LIMITATIONS AND EXCLUSIONS 13.1 General limitations: A. The inspector is NOT required to perform any action or make any determination not specifically stated in these Standards of Practice. B. Inspections performed in accordance with these Standards of Practice: 1. are not technically exhaustive. 2. are not required to identify concealed conditions, latent defects, or consequential damage(s). C. These Standards of Practice are applicable to buildings with four or fewer dwelling units and their garages or carports. 13.2 General exclusions: A. Inspectors are NOT required to determine: 1. conditions of systems or components that are not readily accessible. 2. remaining life expectancy of any system or component. 3. strength, adequacy, effectiveness, or efficiency of any system or component. 4. the causes of any condition or deficiency. 5. methods, materials, or costs of corrections. 6. future conditions including but not limited to failure of systems and components. 7. the suitability of the property for any specialized use. 8. compliance with regulatory requirements (codes, regulations, laws, ordinances, etc.). 9. market value of the property or its marketability. 10. the advisability of purchase of the property. 11. the presence of potentially hazardous plants or animals including, but not limited to, wood destroying organisms or diseases harmful to humans including molds or mold-like substances. 12. the presence of any environmental hazards including, but not limited to, toxins, carcinogens, noise, and contaminants in soil, water, and air. 13. the effectiveness of any system installed or method utilized to control or remove suspected hazardous substances. 14. operating costs of systems or components. 15. acoustical properties of any system or component. 16. soil conditions relating to geotechnical or hydrologic specialties. B. Inspectors are NOT required to offer: 1. or perform any act or service contrary to law. 2. or perform engineering services. 3. or perform any trade or any professional service other than home inspection. 4. warranties or guarantees of any kind. C. Inspectors are NOT required to operate: 1. any system or component that is shut down or otherwise inoperable. 2. any system or component that does not respond to normal operating controls. 3. shut-off valves or manual stop valves. D. Inspectors are NOT required to enter: 1. any area that will, in the opinion of the inspector, likely be dangerous to the inspector or other persons or damage the property or its systems or components. 2. under-floor crawl spaces or attics that are not readily accessible. E. Inspectors are NOT required to inspect: 1. underground items including but not limited to underground storage tanks or other underground indications of their presence, whether abandoned or active. 2. items that are not installed. 3. installed decorative items. 4. items in areas that are not entered in accordance with 13.2.D. 5. detached structures other than garages and carports. 6. common elements or common areas in multi-unit housing, such as condominium properties or cooperative housing. F. Inspectors are NOT required to: 1. perform any procedure or operation that will, in the opinion of the inspector, likely be dangerous to the inspector or other persons or damage the property or its systems or components. 2. describe or report on any system or component that is not included in the Standards and was not inspected. 3. move personal property, furniture, equipment, plants, soil, snow, ice, or debris. 4. dismantle any system or component.

ILLUSTRATIONS

The shingles are comprised of asphalt or fiberglass materials impregnated with mineral granules that are designed to deflect the deteriorating ultra-violet rays of the sun. The most common of these roofs are warranted by manufacturers to last from fifteen to twenty-five years. The actual service life of the roof will vary, depending on a number of interrelated factors including the quality of the material and the method of installation. Regular maintenance will certainly extend the life of any roof.

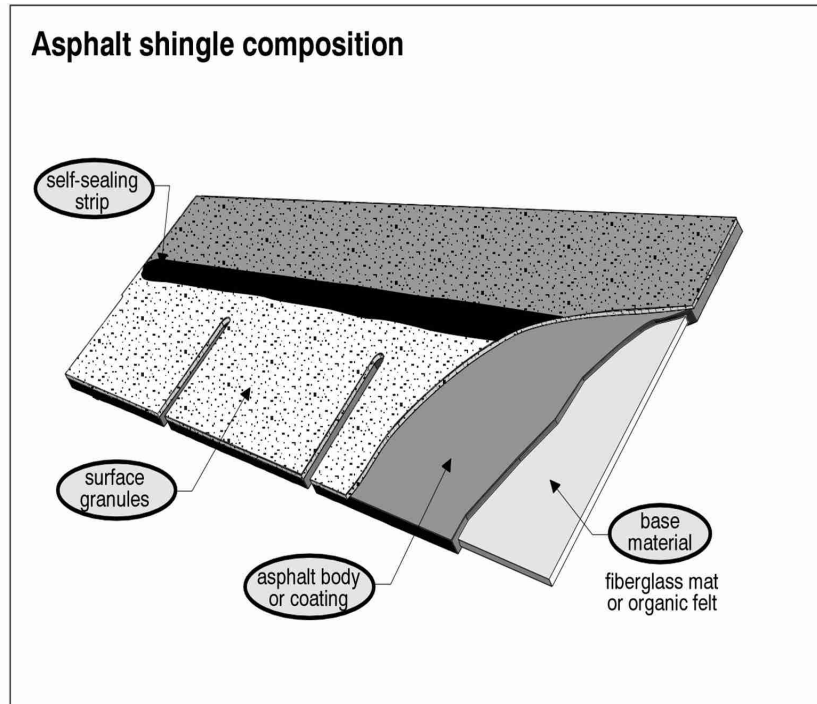

Illustration - 1 Asphalt Shingle Roof Installed - Illustration

Factory built pre-fab fireplaces can provide a home with warmth and atmosphere. But, if they are mis-used, they can create problems for a homeowner.

A factory built fireplace or pre-fab is a component system consisting of the chimney system itself, the fire-stop spacers, the chimney components, the elbows, the offsets, etc. When a manufacturer goes to a listing agency, they test and list the unit as a total system.

When someone starts interchanging and substituting components, the fireplace may not function the way it did during the stringent testing and manufacturers can no longer guarantee its safety.

Any change made to any component can void the listing and the manufacturer's warranty.

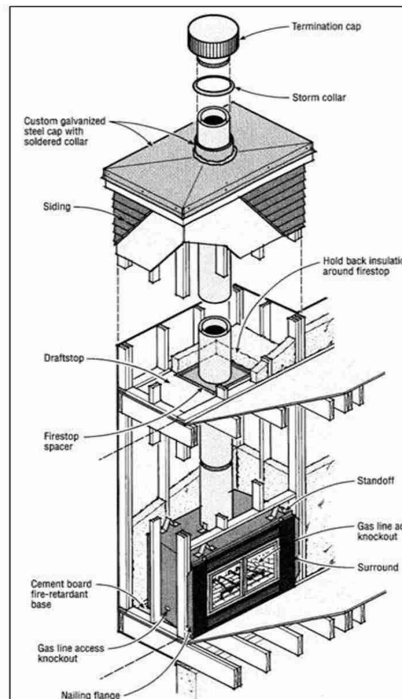

Illustration - 2 Prefabricated Chimney

ILLUSTRATIONS

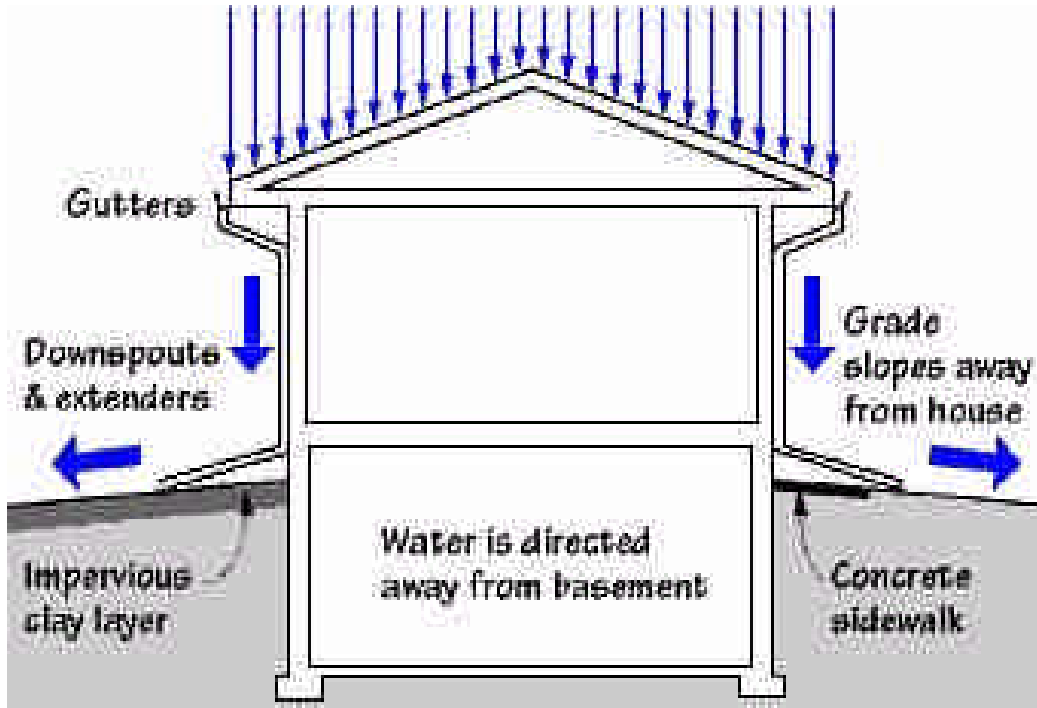

Illustration - 3 Appears functional

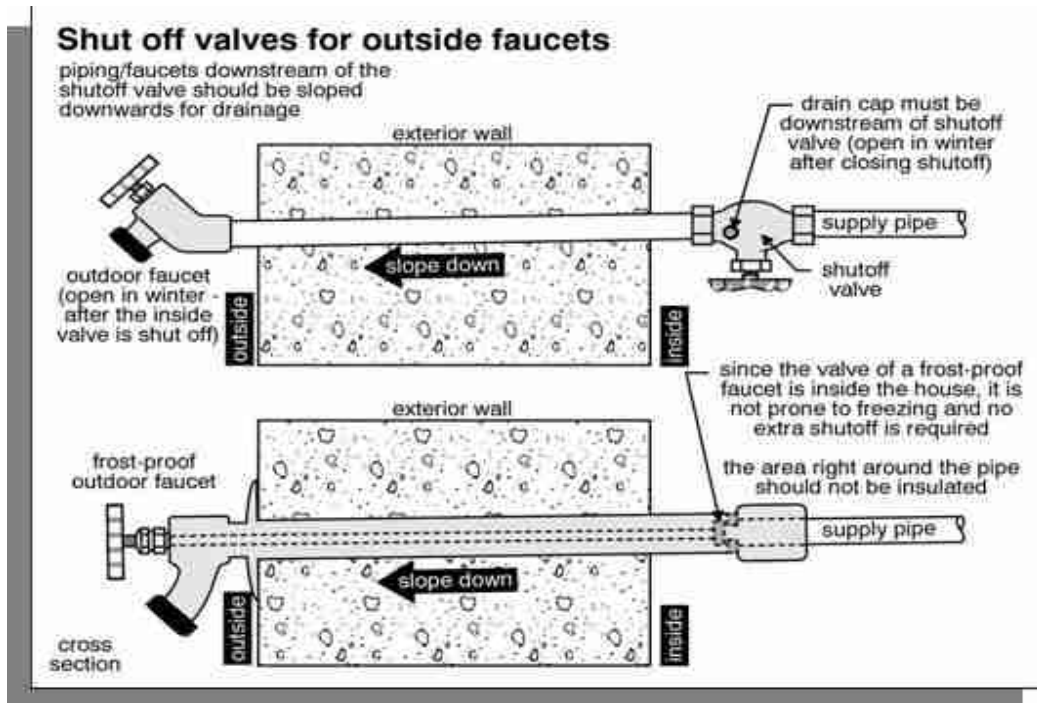

Illustration - 4 Frost-free

ILLUSTRATIONS

We are not HVAC professionals.
Feel free to hire one prior to closing.

This inspection of the heating system is a visual inspection using only the normal operating controls for the system. The inspection of the heating is general and not technically exhaustive. A detailed evaluation of the interior components of the heating system is beyond the scope of a home inspection. It is essential that any recommendation that we make for service, correction, or repair be scheduled prior to closing or purchasing the property, because the hired-professional could reveal defects or recommend further repairs that could affect your evaluation of the property.

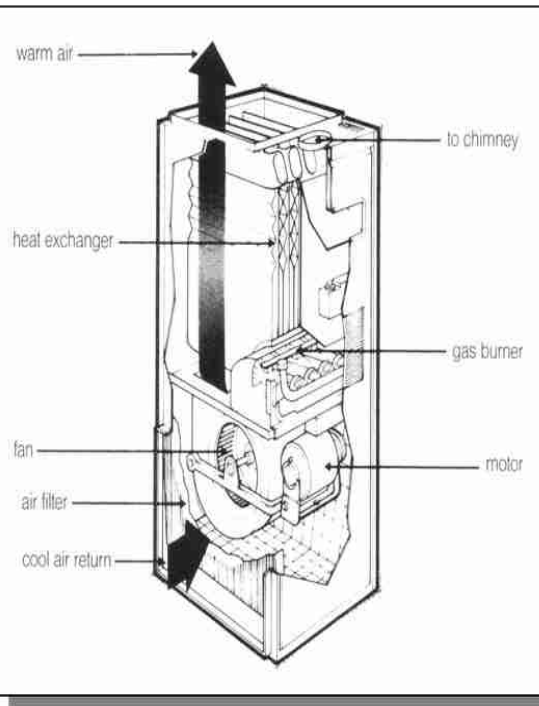

Illustration - 5 Heating system inspected by using normal operating controls

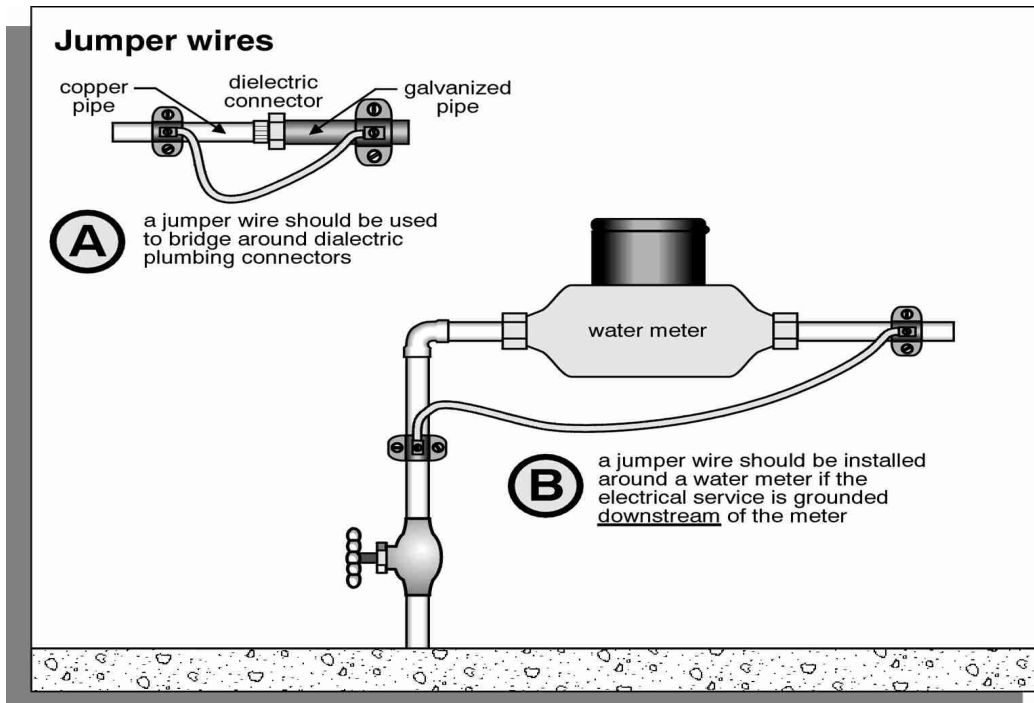

Illustration - 6 Jumper cable installed - Good

ILLUSTRATIONS

There are a wide variety of residential water heaters. They can be expected to last at least as long as their warranty, or from five to eight years, but they will generally last longer. However, few of them last longer than fifteen or twenty years and many eventually leak.

It is wise to have them installed over a drain pan to catch a leaking tank. Also, it is prudent to flush them annually to remove minerals.

The water temperature should be set at a minimum of 110 degrees fahrenheit to kill microbes and a maximum of 140 degrees to prevent scalding.

Water heaters can be dangerous if they are not equipped with a pressure/temperature relief valve and its discharge pipe extended to within 6 inches of the floor.

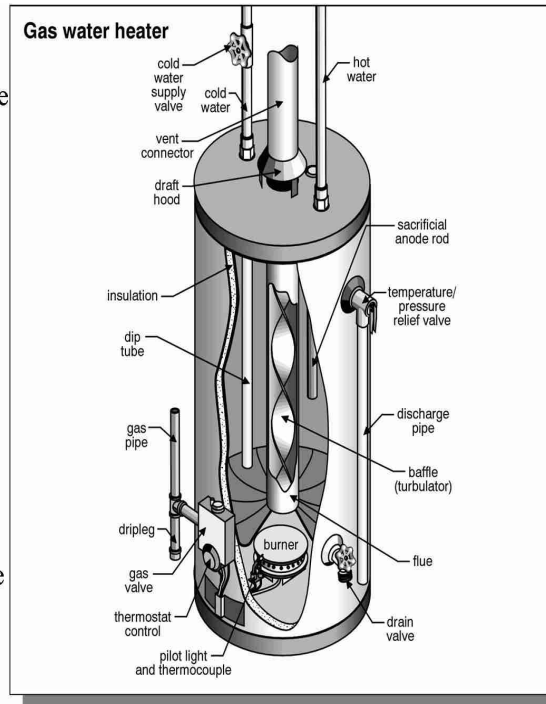

Illustration - 7 For Your Information - Gas Water Heater Tank

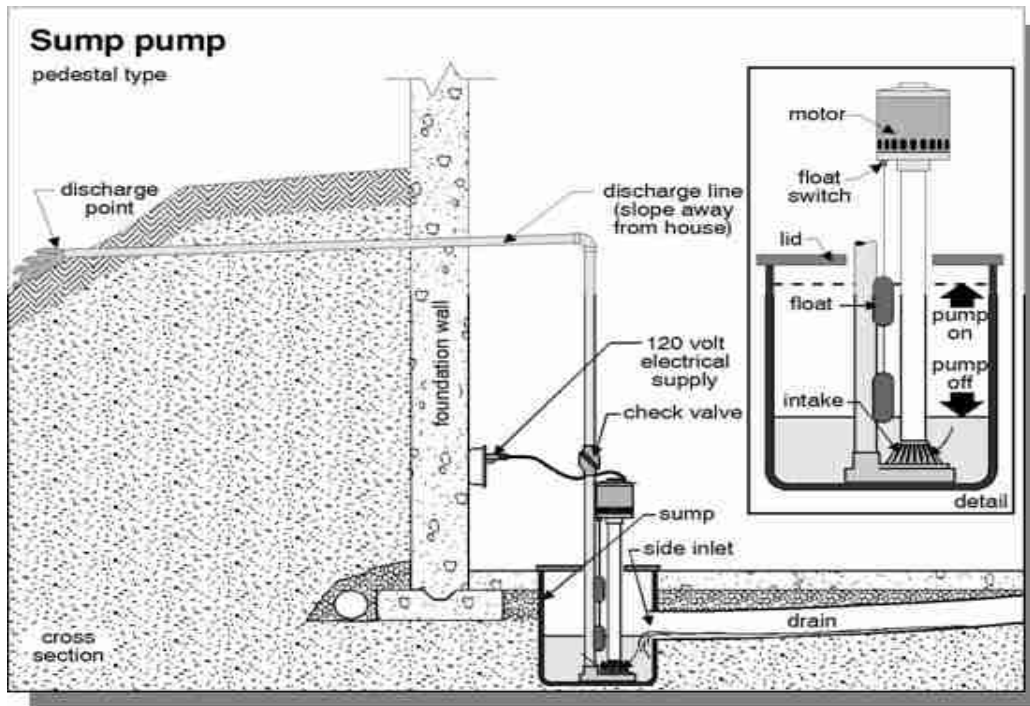

Illustration - 8 A sump pump being used - why

ILLUSTRATIONS

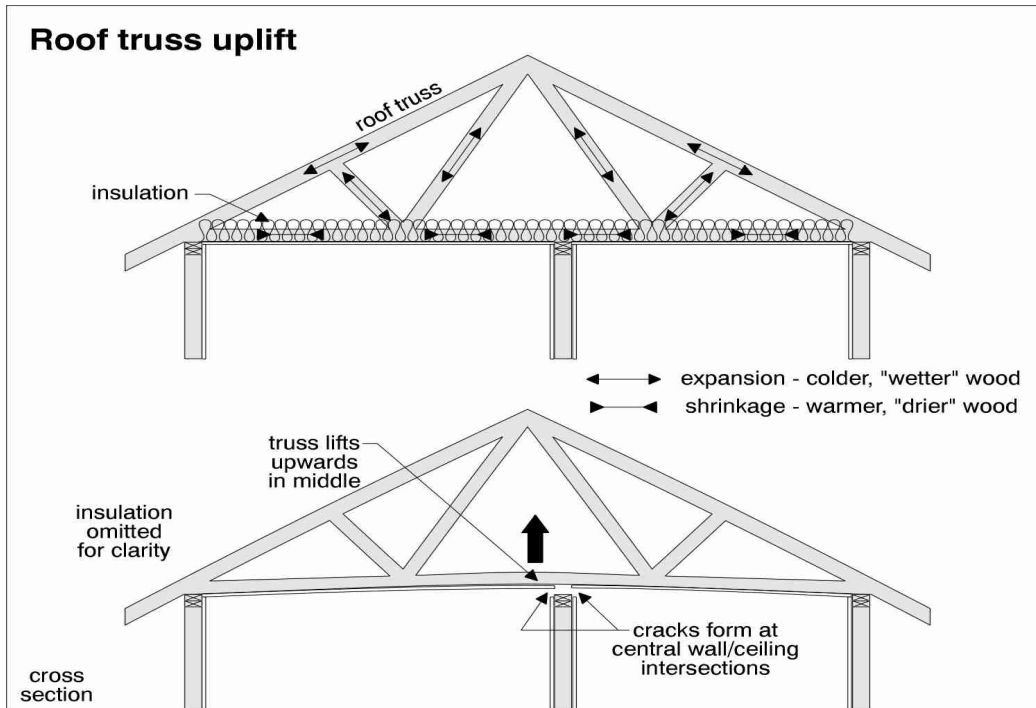

Illustration - 9 Engineered truss

REPORT CONCLUSION & WALK-THROUGH

416 Honeysuckle Court, Yardley, PA 19067

CONCLUSION:

We are proud of our service, and trust that you will be happy with the quality of our report. We have made every effort to provide you with an accurate assessment of the condition of the property and its components and to alert you to any significant defects or adverse conditions. However, we may not have tested every outlet, and opened every window and door, or identified every problem. Also because our inspection is essentially visual, latent defects could exist. We can not see behind walls. Therefore, you should not regard our inspection as a guarantee or warranty. It is simply a report on the general condition of a property at a given point in time. As a homeowner, you should expect problems to occur. Roofs will leak, basements may have water problems, and systems may fail without warning. We can not predict future events. For these reasons, you should keep a comprehensive insurance policy current.

This report was written exclusively for our Client. It is not transferable to other people. The report is only supplemental to a seller's disclosure.

Thank you for taking the time to read this report, and call us if you have any questions. We are always attempting to improve the quality of our service and our report.

PRE-CLOSING WALK THROUGH:

The walk-through prior to closing is the time for Client to inspect the property. Conditions can change between the time of a home inspection and the time of closing. Restrictions that existed during the inspection may have been removed for the walk-through. Defects or problems that were not found during the home inspection may be discovered during the walk-through. Client should be thorough during the walk-through.

Any defect or problem discovered during the walk-through should be negotiated with the owner/seller of the property prior to closing. Purchasing the property with a known defect or problem releases PEACH of all responsibility. Client assumes responsibility for all known defects after settlement.

The following are recommendations for the pre-closing walk through your new house. Consider hiring a certified home inspector to assist you.

1. Check the heating and cooling system. Turn the thermostat to heat mode and turn the temperature setting up. Confirm that the heating system is running and making heat. Turn the thermostat to off and wait 20 minutes. Turn the thermostat to cool mode and turn the temperature setting down. Confirm the condenser is spinning and the system is making cool air. The cooling system should not be checked if the temperature is below 60 degrees or if the temperature was below freezing the night before the walk-through. And you should not operate a heat pump in the heating mode when it is over 75 degrees outside.
2. Operate all appliances.
3. Run water at all fixtures and flush toilets. Look for plumbing leaks.
4. Operate all exterior doors, windows, and locks.
5. Test smoke and carbon monoxide detectors.
6. Ask for all remote controls to any garage door openers, fans, gas fireplaces, etc.
7. Inspect areas that may have been restricted at the time of the inspection.
8. Ask seller questions about anything that was not covered during the home inspection.
9. Ask seller about prior infestation treatment and warranties that may be transferable.
10. Read the seller's disclosure.

Sincerely,
Ben Gromicko, Vice-President



Monday, October 01, 2007

Property Owner
416 Honeysuckle Court
Yardley, PA 19067

Dear Property Owner:

We understand that a home inspection can be a stressful process. During our inspection, we make every effort to respect your home and leave it as we found it.

All of the inspectors at PEACH bring clean shoes that are worn indoors only.

During the inspection we look at over 500 different items, some which need to be tested, opened and closed, and turned off and on. We try to put back those items to the original setting or condition, but some items may have been overlooked. Here is a list of some things you may want check and make sure that they are back as they were prior to the inspection.

- Thermostat for the heating/air conditioning system
- GFCI receptacles or breakers (Ground Faults)
- Refrigerators or freezers in basement or garage
- Clocks
- Kitchen appliances
- Doors
- Coffee makers
- Curtains, drapes and blinds

We are always looking to improve our company and our inspections services. If we failed to leave your home in satisfactory condition or if you have any comments or suggestions, we would welcome your feedback.

Sincerely,

Benjamin Gromicko
Vice-President
PEACH Inspections